

# Terval/AP

High - Medium Pressure Gas Regulator



INDUSTRIAL VALVE SOLUTION  
**MIX FLOW**  
Grupa Baltina [www.mixflow.com.pl](http://www.mixflow.com.pl)

**MIXFLOW – ENERGY**  
PL 80 – 314 Gdańsk,  
Al. Grunwaldzka 303  
Tel: +48 58 676 55 39  
[info@mixflow.com.pl](mailto:info@mixflow.com.pl)



**TECHNICAL BROCHURE**

**Pietro Fiorentini S.p.A.**

Via E.Fermi, 8/10 | 36057 Arcugnano, Italy | +39 0444 968 511  
sales@fiorentini.com

The data are not binding. We reserve the right  
to make changes without prior notice.

tervalap\_technicalbrochure\_ENG\_revA

**[www.fiorentini.com](http://www.fiorentini.com)**

# Who we are

We are a global organization that specializes in designing and manufacturing technologically advanced solutions for natural gas treatment, transmission and distribution systems.

We are the ideal partner for operators in the Oil & Gas sector, with a business solutions that span the whole natural gas chain.

We are constantly evolving to meet our customers' highest expectations in terms of quality and reliability.

Our aim is to be a step ahead of the competition, with customized technologies and an after-sale service program undertaken with the highest level of professionalism.



## Pietro Fiorentini advantages



Localised technical support



Experience since 1940



Operating in over 100 countries

# Area of Application

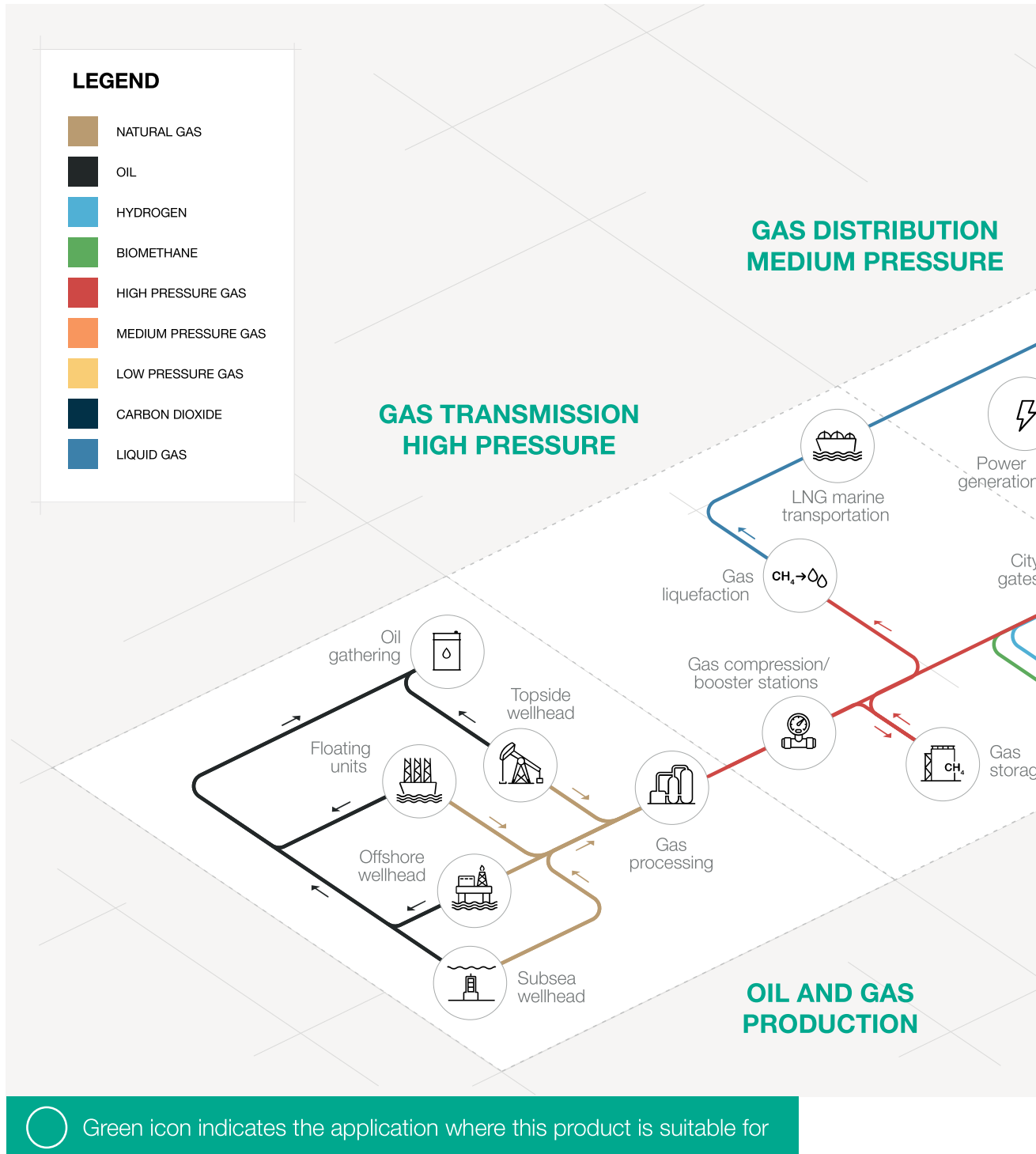

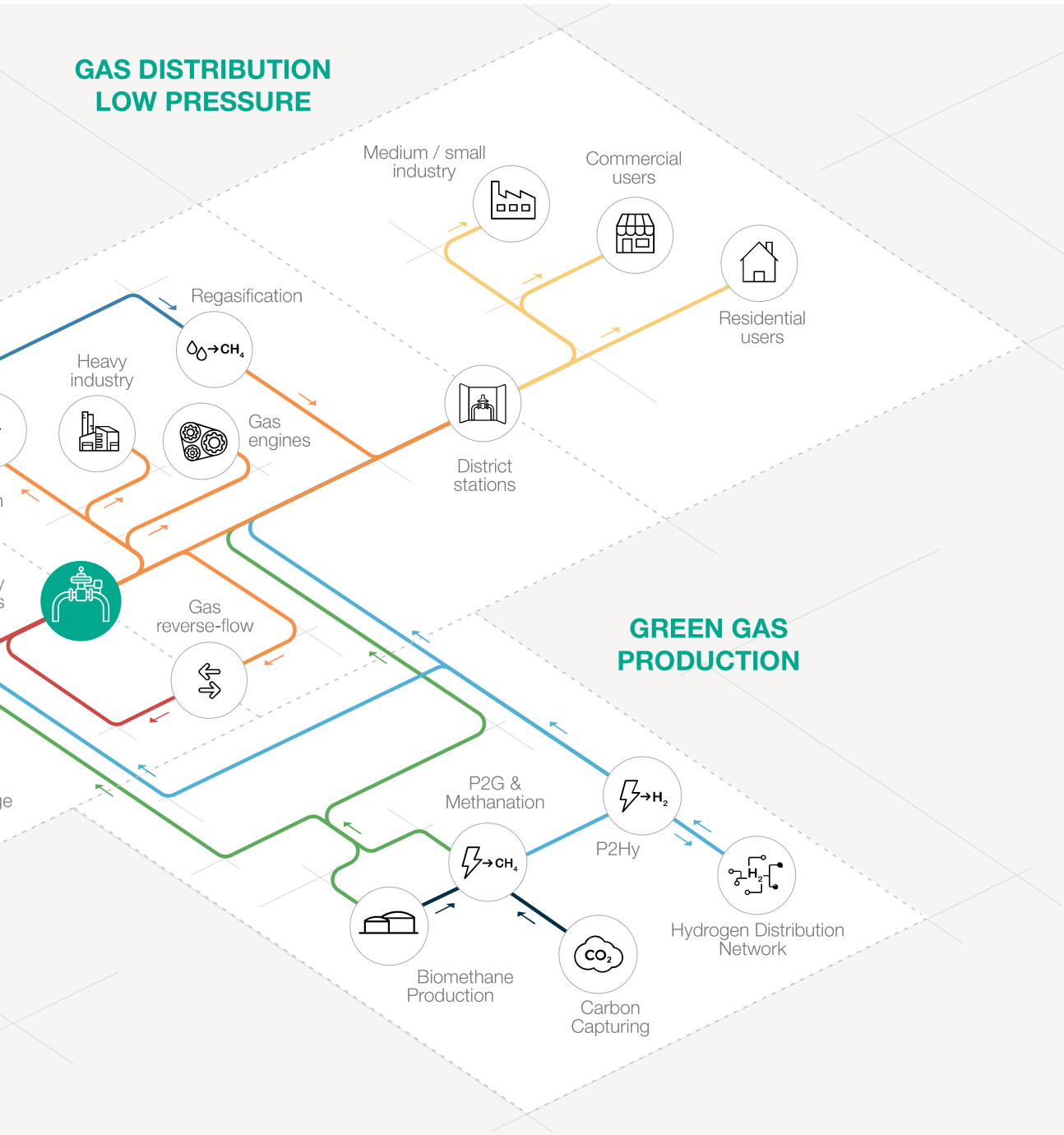

Figure 1 Area of Application Map



# Introduction

The **Terval/AP** by Pietro Fiorentini is a **pilot-operated** gas pressure regulator.

Mainly used for high and medium pressure natural gas distribution networks.

It should to be used with previously filtered non-corrosive gases.

According to the European Standard EN 334, it is classified as **Fail Close**.

The Terval/AP is **Hydrogen Ready** for NG-H2 blending.

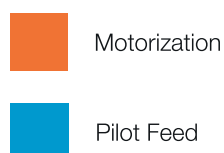
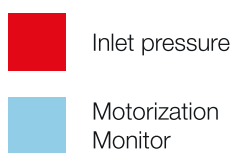
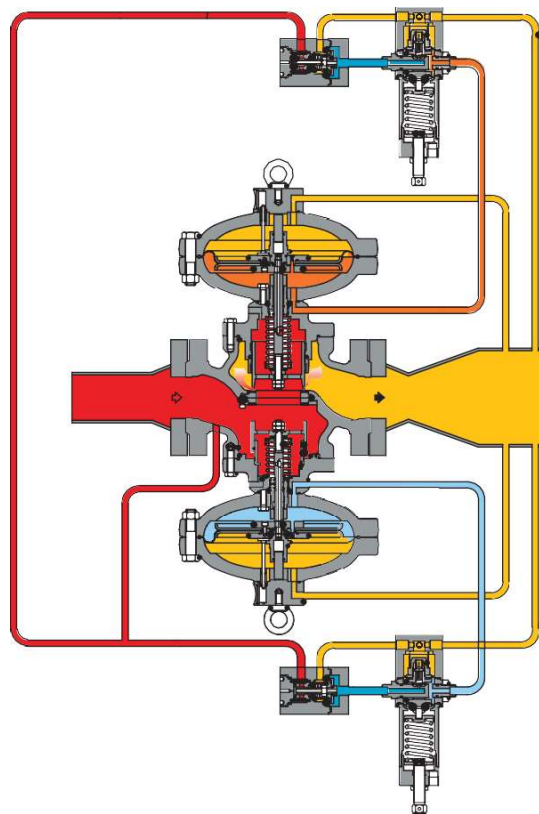

**Figure 2** Terval/R

# Features and Calibration ranges

**Terval/AP** is a **pilot-operated** device for high and medium pressure with a unique **dynamic balancing system** which ensures an **outstanding turn down ratio** combined with an extremely **accurate outlet pressure control**.

A balanced pressure regulator it is a pressure regulator where delivery pressure accuracy it is not affected by the fluctuation of the inlet pressure and flow during its operation. Therefore, a balance pressure regulator can have a single orifice for all pressure and flow operating conditions.

This regulator is suitable for use with previously filtered, non corrosive gases and distribution networks.

It is a **truly top entry design** which allows an **easy maintenance** of parts directly in the field **without removing the body from the pipework**.











Set point adjustment of the regulator is operated via a pilot unit used to load and unload the bottom chamber.

The modular design of Terval/AP pressure regulators allows to have both emergency monitor PM/182 and slam shut SB/82 simultaneously on the same body.

Futhermore it can be equipped with silencer DB/819 model on the same body too.



## Terval/AP competitive advantages

-  Balanced type
-  Top Entry
-  Fail Close plug and seat regulator
-  Easy maintenance
-  High accuracy
-  1:1000 High turn-down ratio
-  3X 3 functions in 1 body
-  Built-in accessories
-  Built-in pilot filter
-  Biomethane compatible and 20% Hydrogen blending compatible. Higher blending available on request

## Features

Features	Values
Design pressure* (PS <sup>1</sup> / DP <sup>2</sup> )	up to 10.2 MPa up to 102 barg
Ambient temperature* (TS <sup>1</sup> )	from -20 °C to +60 °C from -4 °F to +140 °F
Inlet gas temperature*	from -20 °C to +60 °C from -4 °F to +140 °F
Inlet pressure (MAOP / p <sub>umax</sub> <sup>1</sup> )	from 0.05 to 10.0 MPa from 0.5 to 100 barg
Range of downstream pressure (Wd <sup>1</sup> )	from 0.03 to 7.4 MPa from 0.3 to 74 barg
Available accessories	DB/819 Silencer
Minimum operating differential pressure (Δp <sub>min</sub> <sup>1</sup> )	0.05 MPa   0.5 barg
Accuracy class (AC <sup>1</sup> )	up to 1
Lock-up pressure class (SG <sup>1</sup> )	up to 2.5
Nominal size (DN <sup>1,2</sup> )	DN 25   1"; DN 50   2"; DN 80   3"; DN 100   4" **;
Connections	Class 300, 600 RF or RTJ according to ASME B16.5

(<sup>1</sup>) according to EN334 standard  
 (<sup>2</sup>) according to ISO 23555-1 standard  
 (\*) NOTE: Different functional features and/or extended temperature ranges may be available on request. Stated inlet gas temperature range is the maximum for which the equipment's full performance, including accuracy is guaranteed. Product may have a different pressure or temperature ranges according to the version and/or installed accessories.  
 (\*\*) available on special request.

**Table 1** Features



# Materials and Approvals

Part	Material
Body	ASTM A 352 LCC cast steel for classes ANSI 600 and 300;
Heads	ASTM A 350 LF2 steel
Stem	AISI 416 stainless steel
Plug	ASTM A 350 LF2 nickel-plated steel
Seat	Vulcanized Nitrile Rubber on metal support
Diaphragm	Rubberised Canvas (pre-formed by hot-pressing process)
O-rings	Nitrile Rubber
Compression fittings	Made of zinc-plated steel according to DIN 2353; on request, stainless steel

**NOTE:** The materials indicated above refer to the standard models. Different materials can be provided according to specific needs.

**Table 2** Materials

## Construction Standards and Approvals

**Terval/AP** regulator is designed according to the European standard EN 334. The regulator reacts in closing (Fail Close) according to EN 334.

The product is certified according to European Directive 2014/68/EU (PED). Leakage class: bubble tight, better than VIII according to ANSI/FCI 70-3.



EN 334



PED-CE\*

\*limited to 1" and 2"



# Pilot ranges and types

Type	Model	Operation	Range Wh		Spring Table web link
			MPa	barg	
Main pilot	204/A	Manual	0.03 - 4.3	0.3 - 43	<a href="#">TT 433</a>
Main pilot	205/A	Manual	2 - 6	20 - 60	<a href="#">TT 799</a>
Main pilot	207/A	Manual	4.1 - 7.4	41 - 74	<a href="#">TT 1146</a>

**Table 3** Settings Table

Pilot adjustment	
Pilot type .../A	Manual setting
Pilot type .../D	Electric remote setting control
Pilot type .../CS	Pneumatic remote setting control
Pilot type .../FIO	Smart unit for remote setting, monitoring, flow limitation

**Table 4** Pilot adjustment table

General link to the calibration tables: [PRESS HERE](#) or use the QR code:



# Accessories

**For the pressure regulators:**

- Cg limiter
- Silencer

**For the pilot circuit:**

- Supplementary filter CF14 or CF14/D

## Incorporated monitor and slam shut

The unique feature of Terval series pressure regulators is to have emergency monitor and slam shut device incorporated together with the active regulator in the same body.

This provides a three functions device in a single body allowing smaller footprint for the installation.



## PM/819 monitor

**This emergency regulator (monitor) is directly integrated** onto the body of the main regulator. Both pressure regulators, therefore, use the same valve body, although they have independent actuators, pilots and valve seats.









The monitor is in the fully open position during normal operation of the active regulator and takes over on in the event of its failure.

The operational characteristics of the PM/819 monitor are the same as the Reflux 819 regulator (refer to that specific catalogue).

The Cg coefficients of regulator having an incorporated monitor is 5% lower than those for standard version.

This solution allows the construction of pressure reduction lines with compact dimensions.

Another great advantage offered by the incorporated monitor regulator is that **it can be installed at any time**, even on an existing regulator, **without major changes to the pipeline.**

-  Compact dimensions
-  Completely independent
-  Fail to close action
-  Built-in pilot's filter
-  Visual opening indicator
-  Easy maintenance
-  Limit switch option
-  Accelerator option

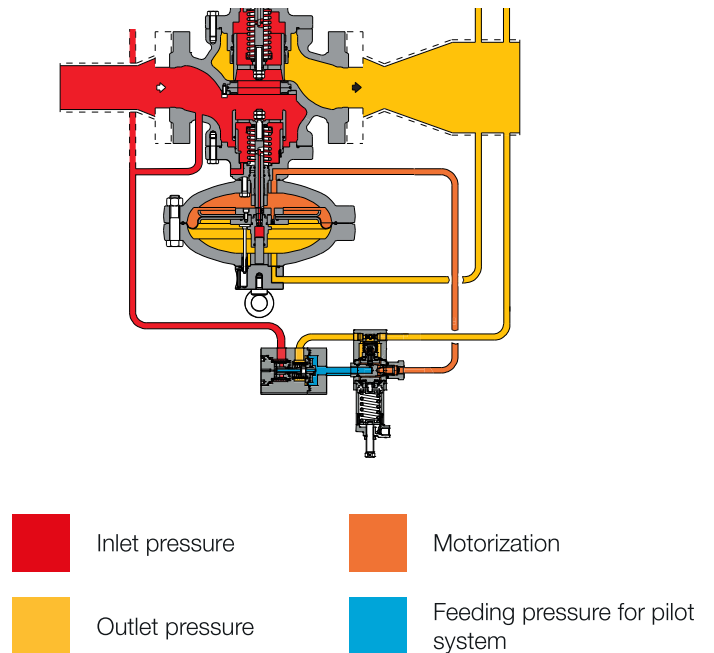

**Figure 3** Terval/AP monitor PM/819

Type	Model	Operation	Range Wh		Spring Table web link
			MPa	barg	
Main pilot	204/A	Manual	0.03 - 4.3	0.3 - 43	<a href="#">TT 433</a>
Main pilot	205/A	Manual	2 - 6	20 - 60	<a href="#">TT 799</a>
Main pilot	207/A	Manual	4.1 - 7.4	41 - 74	<a href="#">TT 1146</a>

Table 5 Settings table

Types of pilot adjustment	
Pilot type .../A	Manual setting
Pilot type .../D	Electric remote setting control
Pilot type .../CS	Pneumatic remote setting control
Pilot type .../FIO	Smart unit for remote setting, monitoring, flow limitation

Table 6 Pilot adjustment table

The monitor regulator can be equipped with an additional pilot called “accelerator” to enable a quick response time during the monitor take over. According to PED the accelerator is required on the monitor when acting as a safety accessory.

Type	Model	Operation	Range Wh		Spring Table web link
			MPa	barg	
Accelerator	M/A	Manual	0.03 - 2	0.3 - 20	<a href="#">TT 354</a>
Accelerator	M/A1	Manual	2 - 6.3	20 - 63	<a href="#">TT 892</a>
Accelerator	M/A2	Manual	4 - 7.5	40 - 75	<a href="#">TT 892</a>

Table 7 Accelerator adjustment table

General link to the calibration tables: [PRESS HERE](#) or use the QR code:





## DB/819 silencer

Whenever certain noise limit is desired, an additional silencer allows to considerably reduce the noise level (dBA).

The Terval/AP pressure regulator can be supplied with an **incorporated silencer** in either the standard version or version with incorporated slam shut or monitor regulator.

The high efficiency noise absorption takes place at the point where the noise is generated, thus preventing its propagation.

With the built-in silencer, the Cg valve coefficient is 5% lower than the corresponding version without.

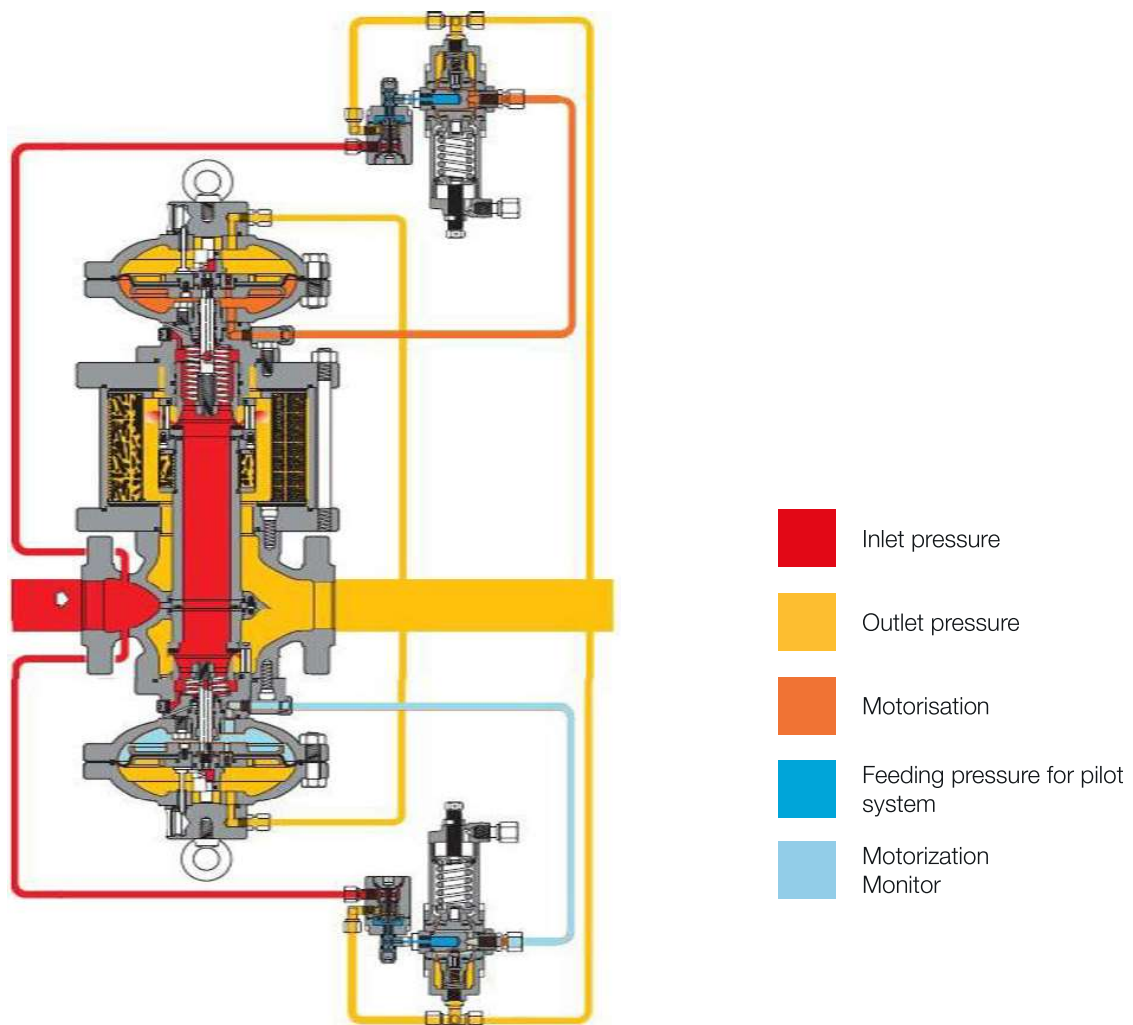

**Figure 4** Terval/AP with DB/819 silencer

The charts below represent the silencer effectiveness based on some common reference conditions for 2", 4". For actual calculations at specific desired conditions please refer to the online sizing tool or contact your closest Pietro Fiorentini representative.

- Pd 0.4 MPa | 4 barg  
NO Silencer
- Pd 2 MPa | 20 barg  
NO SILENCER
- Pd 4 MPa | 40 barg  
NO Silencer
- Recommended noise limit  
(85 dBA at 1 mt | 3 feet)
- Pd 0.4 MPa | 4 barg  
DB/819
- Pd 2 MPa | 20 barg  
DB/819
- Pd 4 MPa | 40 barg  
DB/819

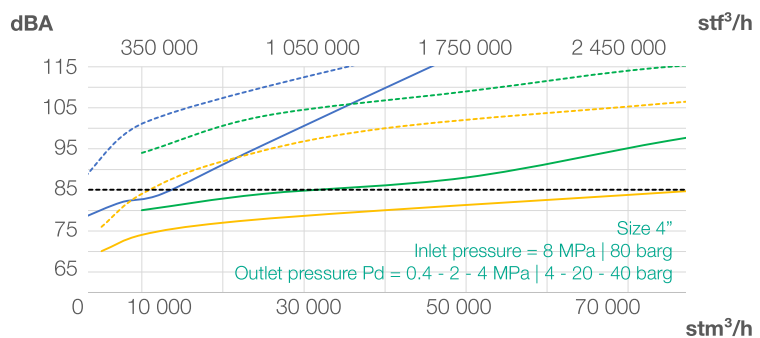
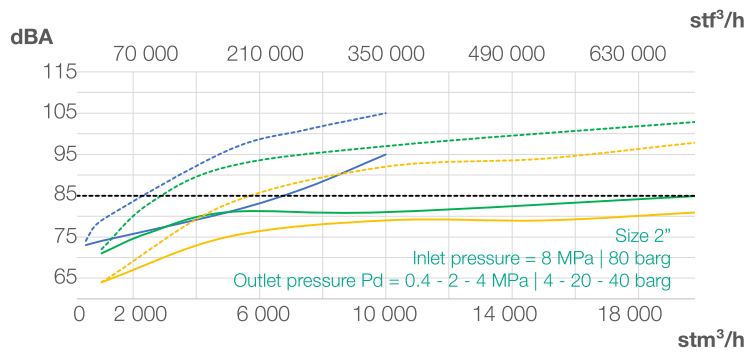
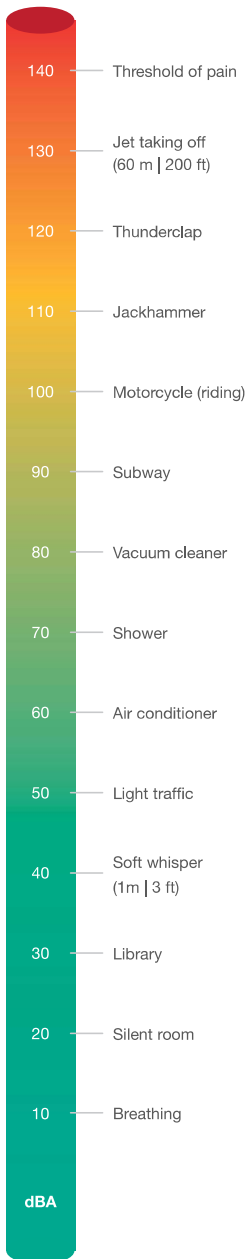









Chart 1 Terval/AP's silencer efficiency charts



## SB/82 slam shut

The Terval/AP pressure regulator has **SB/82 incorporated slam shut valve**.

The main characteristics of this device are:

-  OPSO Over Pressure Shut-Off
-  UPSO Under Pressure Shut-Off
-  Internal by-pass
-  Push button for tripping test
-  Compact dimensions
-  Easy maintenance
-  Remote tripping option
-  Limit switch option

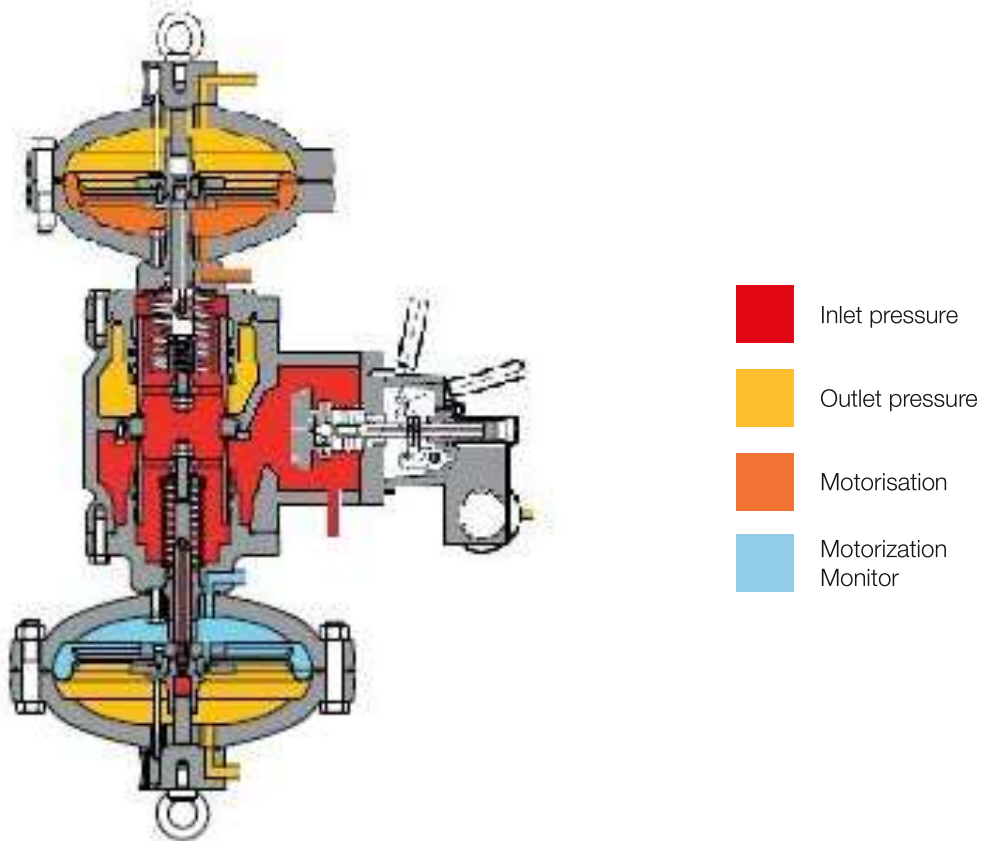

**Figure 5** Reflex 819 with SB/82



Pressure switch types and ranges					
SSV Type	Model	Operation	Range Wh		Spring Table web link
			MPa	barg	
SB/82	102M	OPSO	0.02 - 0.55	0.2 - 5.5	<a href="#">TT 1331</a>
		UPSO	0.02 - 0.28	0.2 - 2.8	
SB/82	102MH	OPSO	0.02 - 0.55	0.2 - 5.5	<a href="#">TT 1331</a>
		UPSO	0.28 - 0.55	2.8 - 5.5	
SB/82	103M	OPSO	0.2 - 2.2	2 - 22	<a href="#">TT 1331</a>
		UPSO	0.02 - 0.8	0.2 - 8	
SB/82	103MH	OPSO	0.2 - 2.2	2 - 22	<a href="#">TT 1331</a>
		UPSO	0.8 - 1.9	8 - 19	
SB/82	104M	OPSO	1.5 - 4.5	15 - 45	<a href="#">TT 1331</a>
		UPSO	0.16 - 1.8	1.6 - 18	
SB/82	104MH	OPSO	1.5 - 4.5	15 - 45	<a href="#">TT 1331</a>
		UPSO	1.8 - 4.1	18 - 41	
SB/82	105M	OPSO	3 - 9	30 - 90	<a href="#">TT 1331</a>
		UPSO	0.3 - 4.4	3 - 44	
SB/82	105MH	OPSO	3 - 9	30 - 90	<a href="#">TT 1331</a>
		UPSO	4.4 - 9	44 - 90	

**Table 10** Settings table



# Weights and Dimensions

## Terval/AP

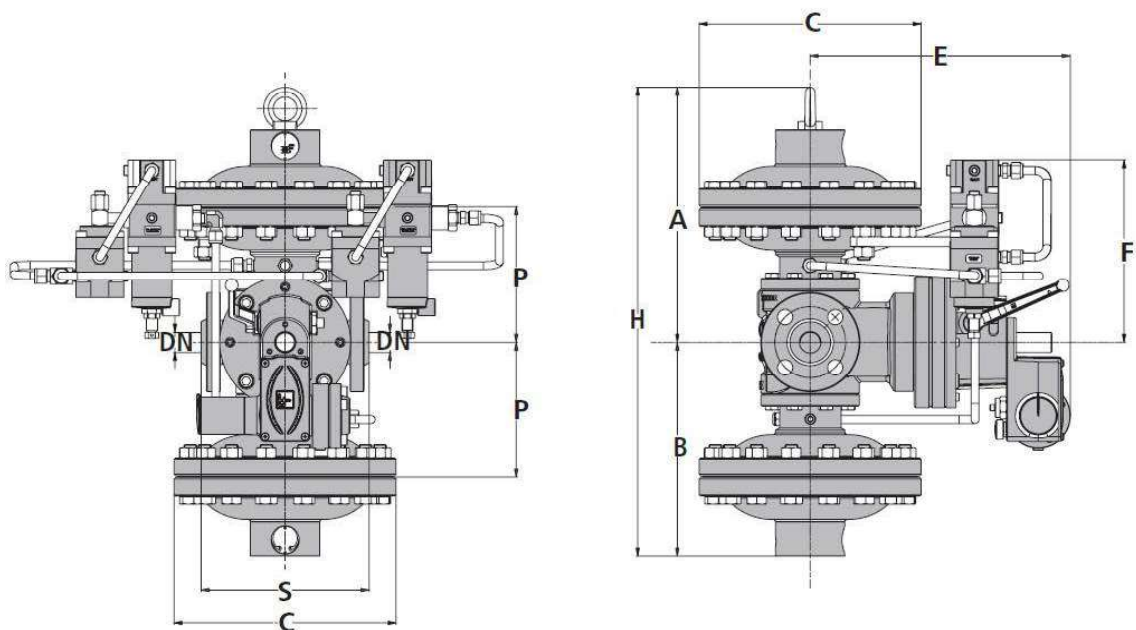

Figure 6 Terval/AP dimensions

Weights and Dimensions (for other connections please contact your closest Pietro Fiorentini representative)								
Size (DN) - [mm]	25		50		80		100	
Size (DN) - inches	1"		2"		3"		4"	
	[mm]	inches	[mm]	inches	[mm]	inches	[mm]	inches
S - ANSI 300	197	7.8"	267	10.5"	317	12.5"	368	14.5"
S - ANSI 600	210	8.3"	286	11.3"	336	13.2"	394	15.5"
A	320	12.6"	350	13.7"	430	16.9"	490	19.3"
B	320	12.6"	350	13.8"	430	16.9"	440	17.3"
C	278	10.9"	278	10.9"	360	14.2"	360	14.2"
E	370	14.6"	382	15.1"	450	17.8"	470*	18.5**
F	260	10.2"	290	11.4"	350	13.8"	380	15.0"
H	640	25.2"	700	27.6"	860	33.4"	930	36.6"
P	170	6.7"	200	7.9"	260	10.2"	290	11.4"
Tube Connections	Øe 10 x Øi 8 (on request imperial sizing)							
Weight	Kg	lbs	Kg	lbs	Kg	lbs	Kg	lbs
ANSI 300	99	218	125	276	212*	467*	301*	664*
ANSI 600	100	220	126	278	215*	474*	310*	683*

Table 11 Weights and dimensions

# Terval/AP + DB/819

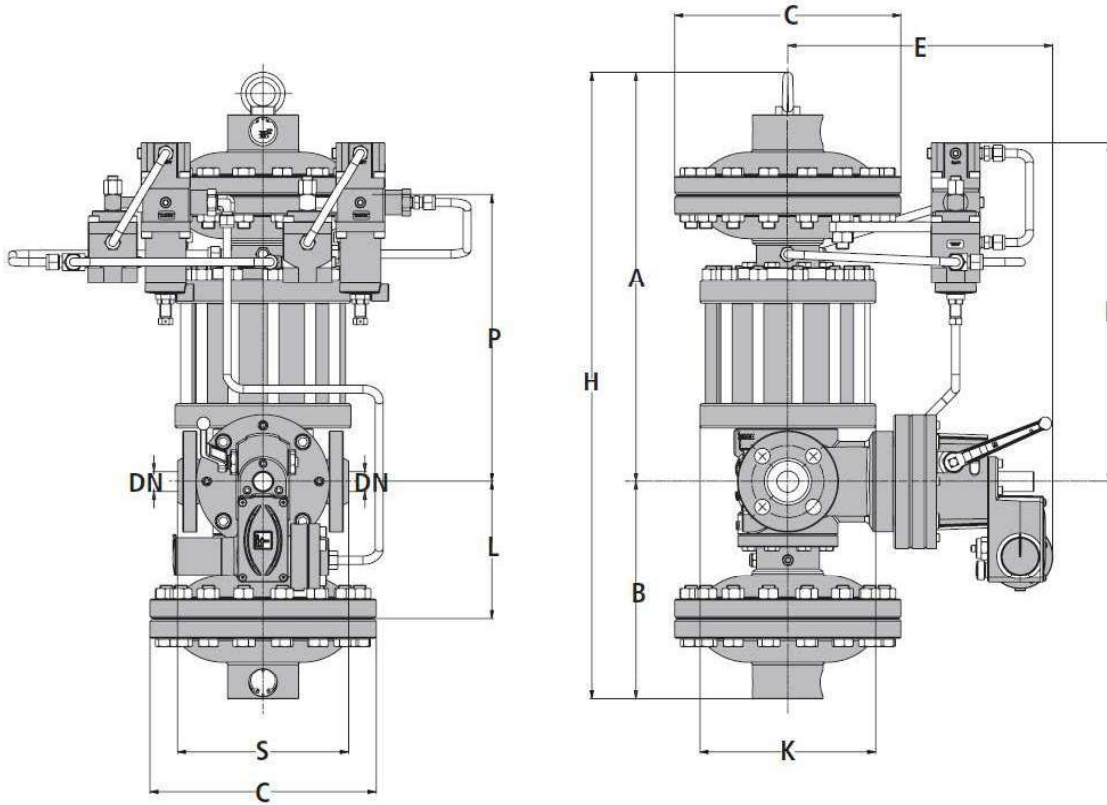

Figure 7 Terval/AP + DB/819

Weights and Dimensions (for other connections please contact your closest Pietro Fiorentini representative)								
Size (DN) - [mm]	25		50		80		100	
Size (DN) - inches	1"		2"		3"		4"	
	[mm]	inches	[mm]	inches	[mm]	inches	[mm]	inches
S - ANSI 300	197	7.8"	267	10.5"	317	12.5"	368	14.5"
S - ANSI 600	210	8.3"	286	11.3"	336	13.2"	394	15.5"
A	520	20.5"	575	22.6"	700	27.6"	800	31.5"
B	320	12.6"	350	13.8"	430	16.9"	440	17.3"
C	278	10.9"	278	10.9"	360	14.2"	360	14.2"
E	325	12.8"	345	13.6"	400*	15.7**	470*	18.5**
F	425	16.7"	495	19.5"	615	24.2"	670	26.4"
H	840	33.1"	925	36.4"	1130	44.5"	1240	48.8"
P	370	14.6"	400	15.7"	505	19.9"	575	22.6"
L	170	6.7"	200	7.9"	260	10.2"	290	11.4"
K	220	8.7"	300	11.8"	330	13.0"	390	15.4"
Tube Connections	Øe 10 x Øi 8 (on request imperial sizing)							
Weight	Kg	lbs	Kg	lbs	Kg	lbs	Kg	lbs
ANSI 300	126	278	190	419	307	677	434*	957*
ANSI 600	127	280	192	423	310	683	443*	977*

Table 12 Weights and dimensions



# Sizing and Cg

In general, the choice of a regulator is made based on the calculation of the flow rate determined by the use of formulae using the flow rate coefficients (Cg) and the form factor (K1) as indicated by the EN 334 standard. Sizing is available through the on-line Pietro Fiorentini sizing program.

Flow rate coefficient				
Nominal size	25	50	80	100
Inches	1"	2"	3"	4"
Cg	515	2050	4450	7200
K1	100	100	100	100

**Table 13** Flow rate coefficient

For sizing [PRESS HERE](#) or use the QR code:



**Note:** In case you do not have the proper credentials to access, feel free to contact your closest Pietro Fiorentini representative.

In general the on-line sizing considers multiple variables as the regulator is installed in a system, enabling a better and multiperspective approach to the sizing.

For different gases, and for natural gas with a different relative density other than 0.61 (compared to air), the correction coefficients from the following formula shall be applied.

$$F_c = \sqrt{\frac{175.8}{S \times (273.16 + T)}}$$

S = relative density (refer to Table 14)  
T = gas temperature ( °C )

$$F_c = \sqrt{\frac{316.44}{S \times (459.67 + T)}}$$

S = relative density (refer to Table 14)  
T = gas temperature ( °F )

Correction Factor Fc		
Gas Type	Relative Density S	Correction Factor Fc
Air	1.00	0.78
Propane	1.53	0.63
Butane	2.00	0.55
Nitrogen	0.97	0.79
Oxygen	1.14	0.73
Carbon Dioxide	1.52	0.63

Note: the table shows the Fc correction factors valid for Gas, calculated at a temperature of 15°C and at the declared relative density.

**Table 14** Correction Factor Fc

Flow rate conversion
Stm <sup>3</sup> /h x 0.94795 = Nm <sup>3</sup> /h

Nm<sup>3</sup>/h reference conditions:  
 T= 0 °C; P= 1 bar | T= 32 °F; P= 14.5 psig  
 Stm<sup>3</sup>/h reference conditions:  
 T= 15 °C; P= 1 bar | T= 59 °F; P= 14.5 psig

**Table 15** Flow rate conversion

**CAUTION:**

In order to get optimal performance, to avoid premature wear on the regulators components, and to limit noise emissions, it is recommended to check the gas speed and its compliance with local practice and regulations. The gas speed at the outlet flange of the regulator which may be calculated by the following formula:

$$V = 345.92 \times \frac{Q}{DN^2} \times \frac{1 - 0.002 \times Pd}{1 + Pd}$$

$$V = 0.0498 \times \frac{Q}{DN^2} \times \frac{14.504 - 0.002 \times Pd}{14.504 + Pd}$$

V = gas speed in m/s  
 Q = gas flow rate in Stm<sup>3</sup>/h  
 DN = nominal size of regular in mm  
 Pd = outlet pressure in barg

V = gas speed in ft/s  
 Q = gas flow rate in Scfh  
 DN = nominal size of regular in inches  
 Pd = outlet pressure in psi



Sizing of regulators is usually made based on valve Cg value (Table 13).

Flow rates at fully open position and various operating conditions are related by the following formulae where:

Q = flow rate in Stm<sup>3</sup>/h

Pu = inlet pressure in bar (abs)

Pd = outlet pressure in bar (abs).

- **A** > when the Cg value of the regulator is known, as well as Pu and Pd, the flow rate can be calculated as follows:

- **A-1** in sub critical conditions: (Pu < 2 x Pd)

$$Q = 0.526 \times C_g \times P_u \times \sin \left( K_1 \times \sqrt{\frac{P_u - P_d}{P_u}} \right)$$

- **A-2** in critical conditions: (Pu ≥ 2 x Pd)

$$Q = 0.526 \times C_g \times P_u$$

- **B** > vice versa, when the values of Pu, Pd and Q are known, the Cg value, and hence the regulator size, may be calculated using:

- **B-1** in sub-critical conditions: (Pu < 2 x Pd)

$$C_g = \frac{Q}{0.526 \times P_u \times \sin \left( K_1 \times \sqrt{\frac{P_u - P_d}{P_u}} \right)}$$

- **B-2** in critical conditions (Pu ≥ 2 x Pd)

$$C_g = \frac{Q}{0.526 \times P_u}$$

NOTE: The sin value is understood to be DEG.

# Customer Centricity

Pietro Fiorentini is one of the main Italian international company with high focus on product and service quality.

The main strategy is to create a stable long-term oriented relationship, putting the customer's needs first. Lean management and thinking and customer centricity are used to improve and maintain the highest level of customer experience.



## Support

One of Pietro Fiorentini's top priorities is to provide support to the client in all phases of project development, during installation, commissioning and operation. Pietro Fiorentini has developed a highly standardized intervention management system, which helps to facilitate the entire process and effectively archive all the interventions carried out, drawing on valuable information to improve the product and service. Many services are available remotely, avoiding long waiting times or expensive interventions.



## Training

Pietro Fiorentini offers training services available for both experienced operators and new users. The training is composed of the theoretical and the practical parts, and is designed, selected and prepared according to the level of use and the customer's need.



## Customer Relation Management (CRM)

The centrality of customer is one of the main missions and vision of Pietro Fiorentini. For this reason, Pietro Fiorentini has enhanced the customer relation management system. This enable to track every opportunity and request from Customer in one single point and make free the information flow.



# Pietro Fiorentini

INDUSTRIAL VALVE SOLUTION  
**MIX** **FLOW**  
Grupa Baltina [www.mixflow.com.pl](http://www.mixflow.com.pl)

**MIXFLOW – ENERGY**  
PL 80 – 314 Gdańsk,  
Al. Grunwaldzka 303  
Tel: +48 58 676 55 39  
[info@mixflow.com.pl](mailto:info@mixflow.com.pl)



**TB0013ENG**



The data are not binding. We reserve the right  
to make changes without prior notice.

tervalap\_technicalbrochure\_ENG\_revA

[www.fiorentini.com](http://www.fiorentini.com)